

EPIC® SENSORS

THREADED TEMPERATURE SENSOR WITH CABLE
TYPE T-SCREW / W-SCREW
DATA SHEET 22



INSTALLATION INSTRUCTIONS AND USER MANUAL

Table of contents

Product description and intended use.....	2
Temperatures, measuring.....	3
Temperatures, ambient.....	3
Temperatures, Ex i versions.....	3
Code key.....	4
Dimensional drawing.....	4
Technical data.....	5
Materials.....	5
Installation instructions.....	6
Tightening torques.....	6
Installation of accessories.....	7
Threaded thermowells:.....	7
Pt100; connection wiring.....	8
Pt100; measuring current.....	8
TC; connection wiring.....	9
TC; non-grounded or grounded types.....	9
TC; thermocouple cable standards (color table).....	10
Type label of standard versions.....	11
Serial number information.....	11
Ex i data (only for types with Ex i approval).....	12
Ex i – Special Conditions for Use.....	12
Ex i certificates and Ex markings.....	12
Ex i type label.....	13
EU Declaration of Conformity.....	14
Manufacturer contact information.....	14
Document history.....	14
ANNEX A: Ex i specifications and special conditions for use	

Product description and intended use

Sensor types T-SCREW (thermocouple, TC) and W-SCREW (resistance, RTD) are threaded temperature sensors with cable.

Sensors are intended for various industrial temperature measuring applications. The construction is designed with screw installation and flat tip measuring element of acid proof steel. The hexagonal nut for driving the threaded screw can be solid (SCREW-S-) or rotating (SCREW-R-).

Sensor element protection tube material can be chosen, and element / cable length can be produced according to customer needs. Wire and cable sheath materials can be chosen.

NOTE! All combinations are not possible, since element ØOD, thread size/length and cable type are depending on each other. For possible combinations, please contact our product specialists.

Measuring elements are rigid, non-bendable versions. Elements can be TC or RTD elements, standard versions are K-type thermocouple (for T-SCREW) and 4-wire Pt100 (for W-SCREW). Element tip is flat, to give an optimal thermal connection to the measured surface.

Tailored versions are produced on request.

Also available as ATEX and IECEx approved protection type Ex i versions. Please see section *Ex i data*.

EPIC® SENSORS temperature sensors are measuring devices intended for professional use. They should be mounted by professionally capable installer who understands the installations surroundings. The worker should understand mechanical and electrical needs and safety instructions of the object installation. Suitable safety gear for each installation task must be used.

Temperatures, measuring

Allowed measuring temperature range for sensor tip is:

- With Pt100 -200...+300 °C, depending on cable material
- With TC -200...+300 °C, depending on TC type and cable material

Temperatures, ambient

Allowed maximum ambient temperature for wires or cable, according to cable type, is:

- SIL = silicone, max. +180 °C
- FEP = fluoropolymer, max. +205 °C
- GGD = glass silk cable/metal braid jacket, max. +350 °C
- FDF = FEP wire insulation/braid shield/FEP jacket, max. +205 °C
- SDS = silicone wire insulation/braid shield/silicone jacket, only available as 2 wire cable, max. +180 °C
- TDT = fluoropolymer wire insulation/braid shield/ fluoropolymer jacket, max. +205 °C
- FDS = FEP wire insulation/braid shield/silicone jacket, max. +180 °C
- FS = FEP wire insulation/silicone jacket, max. +180 °C

Make sure the process temperature is not too much for the cable.

Temperatures, Ex i versions

For Ex i versions only (type designations and -EXI-), specific temperature conditions apply according to the ATEX and IECEx certificates. For more details, please see section: *Ex i data* (only for types with Ex i approval).

Code key

Example code: W — SCREW — R — M8x1 / 10 — 6 — 100 — 5000 / SIL — 4 — A — X

W	= Pt100 resistance thermometer
2xW	= 2 x Pt100 resistance thermometer
T	= thermocouple
2xT	= 2 x thermocouple
SCREW	= sensor with thread (constant in code)
S	= solid structure
R	= rotating structure (easy to assemble, note: does not obstruct gas or liquid flow)
M8x1	= thread size (all available)
10	= thread length [mm]
3, 4, 5, 6, 8	= outer diameter of sensor element (ØOD) [mm]
100	= immersion length, L [mm]
5000	= cable length, CL [mm]
SIL, FEP, GGD, FDF, TDT, SDS, FDS, FS	= cable material (for more information, look technical data on first page of the datasheet)
4,3,2	= Pt100 wire count
K,N,J	= thermocouple type
A,B	= Pt100 accuracy class, (class A as standard delivery)
1,2,3	= thermocouple accuracy class, (class 1 as standard delivery)
EXI	= Ex i certified sensor
X	= additional details on the text line

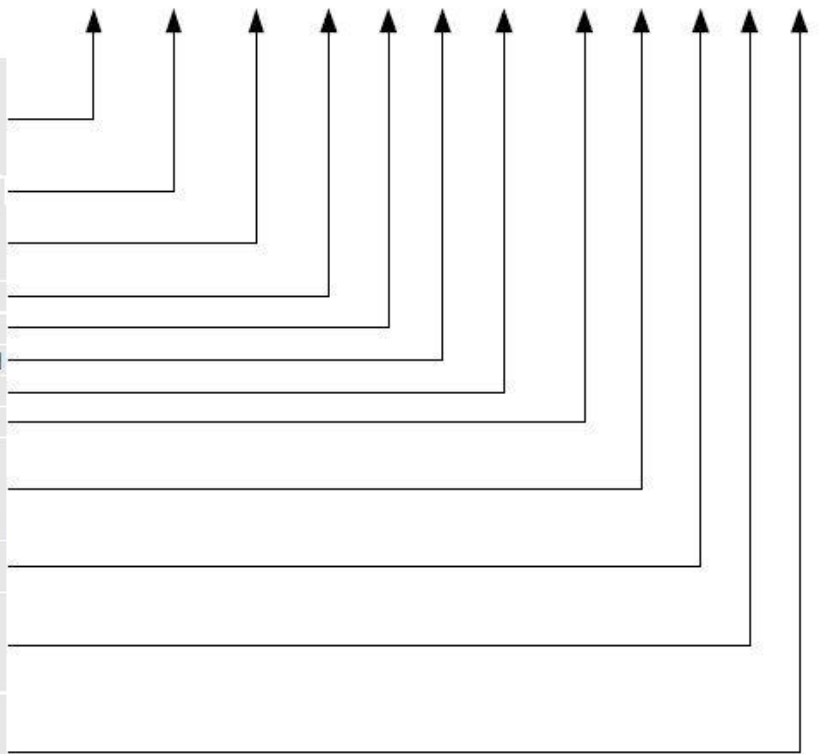

NOTE! For possible combinations of element ØOD, thread size/length and cable type, please contact our product specialists.

Dimensional drawing

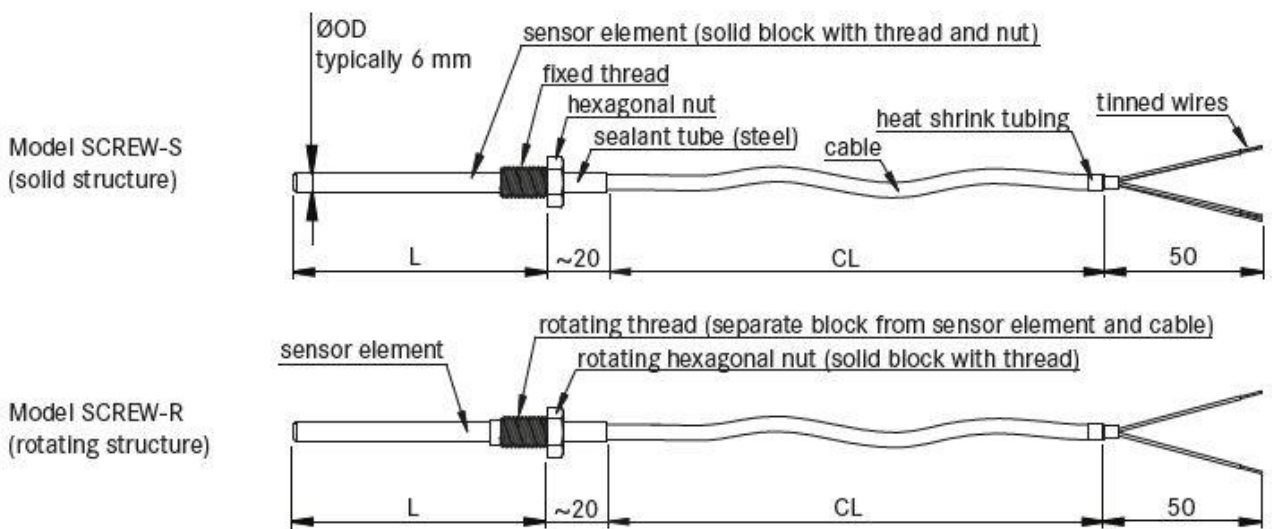

Technical data

Materials	AISI 316L, maximum temperature +250 °C, temporarily +300 °C, other materials on request (Note: overall max. temperature according to the cable)
Diameter	3, 4, 5, 6 or 8 mm, other diameters on request
Thread size and length	According to request, all sizes and lengths available Note: minor diameter of thread cannot be < element diameter
Cable material	SIL = silicone, max. +180 °C FEP = fluoropolymer, max. +205 °C GGD = glass silk cable/metal braid jacket, max. +350 °C FDF = FEP wire insulation/braid shield/FEP jacket, max. +205 °C SDS = silicone wire insulation/braid shield/silicone jacket, only available as 2 wire cable, max. +180 °C TDT = fluoropolymer wire insulation/braid shield/fluoropolymer jacket, max. +205 °C FDS = FEP wire insulation/braid shield/silicone jacket, max. +180 °C FS = FEP wire insulation/silicone jacket, max. +180 °C
Tolerances Pt100 (IEC 60751)	A tolerance $\pm 0.15 + 0.002 \times t$, operating temperature -100...+450 °C B tolerance $\pm 0.3 + 0.005 \times t$, operating temperature -196...+600 °C B 1/3 DIN, tolerance $\pm 1/3 \times (0.3 + 0.005 \times t)$, operating temperature -196...+600 °C B 1/10 DIN, tolerance $\pm 1/10 \times (0.3 + 0.005 \times t)$, operating temperature -196...+600 °C
Tolerances thermocouple (IEC 60584)	Type J tolerance class 1 = -40...375 °C ± 1.5 °C, 375...750 °C $\pm 0.004 \times t$ Type K and N tolerance class 1 = -40...375 °C ± 1.5 °C, 375...1000 °C $\pm 0.004 \times t$
Temperature range Pt100	-200...+300 °C, depending on material
Temperature range thermocouple	-200...+300 °C, depending on thermocouple type and material
Approvals	ATEX, IECEx, METROLOGICAL PATTERN APPROVAL
Quality certificate	ISO 9001:2015 and ISO 14001:2015 issued by DNV

Materials

These are the standard materials of components for the sensor types T-SCREW / W-SCREW.

- | | |
|-----------------------------------|---|
| • Cable/wires | please see <i>Technical data</i> |
| • Heat shrink tube | Irradiated Modified Polyolefin (max. +125 °C),
only on request, not used as standard |
| • Sensor element and sealant tube | AISI 316L |
| • Hexagonal nut | AISI 316L |

Other materials can be used on request.

Installation instructions

Before any installation, make sure the target process/machinery and site are safe to work!

Make sure the cable type matches the temperature and chemical requirements of the site.

Installation phases:

- Insert the sensor tip in a threaded hole, until it is in contact with the surface to be measured.
- Tighten the thread nut clockwise until it is securely closed.
- NOTE! If using model SCREW-S: the thread nut is solid, so both the sensor element and cable must be able to rotate simultaneously with the nut!
- Never bend the sensor element, it is rigid, non-bendable protective tube structure.
- Do not use excess force since it applies pressure on the surface to be measured.
- Make sure there is no excess bending force loading the cable.
- Mount extra strain relief, e.g. cable tie, for cable, if necessary.

Tightening torques

Use only tightening torques allowed in applicable standards of each thread size and material.

Installation of accessories

Threaded thermowells:

If sensor type T-SCREW / W-SCREW needs to be installed with a thermowell, it can be done with the accessory well type TPIE. This thermowell type has both inner and outer threads, which can be produced according to customer specifications. The standard material is acid proof steel, but material can be chosen according to application, special coatings are available, and tailored solutions can be offered according to specific needs.

TPIE Code key: *TPIE - G $\frac{1}{2}$ / G $\frac{1}{2}$ - 9 / 100 - X (example code)*

- TPIE = thermowell model
- G $\frac{1}{2}$ = outer thread 1
- / G $\frac{1}{2}$ = inner thread 2
- 9 = outer diameter \varnothing OD [mm] (\varnothing ID = 7 mm)*
- / 100 = immersion depth L [mm]
- X = additional details on the text line.

* NOTE: inner diameter \varnothing ID is not visible in code.

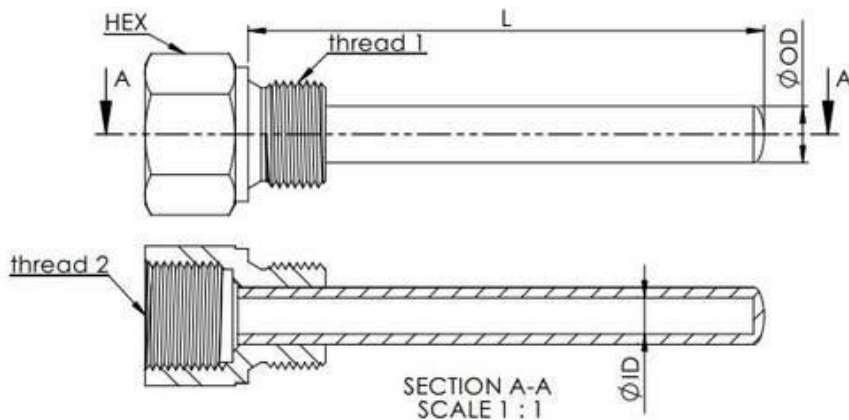

Pt100; connection wiring

Image below: These are the connection colors of Pt100 resistor connections, according to standard EN 60751.

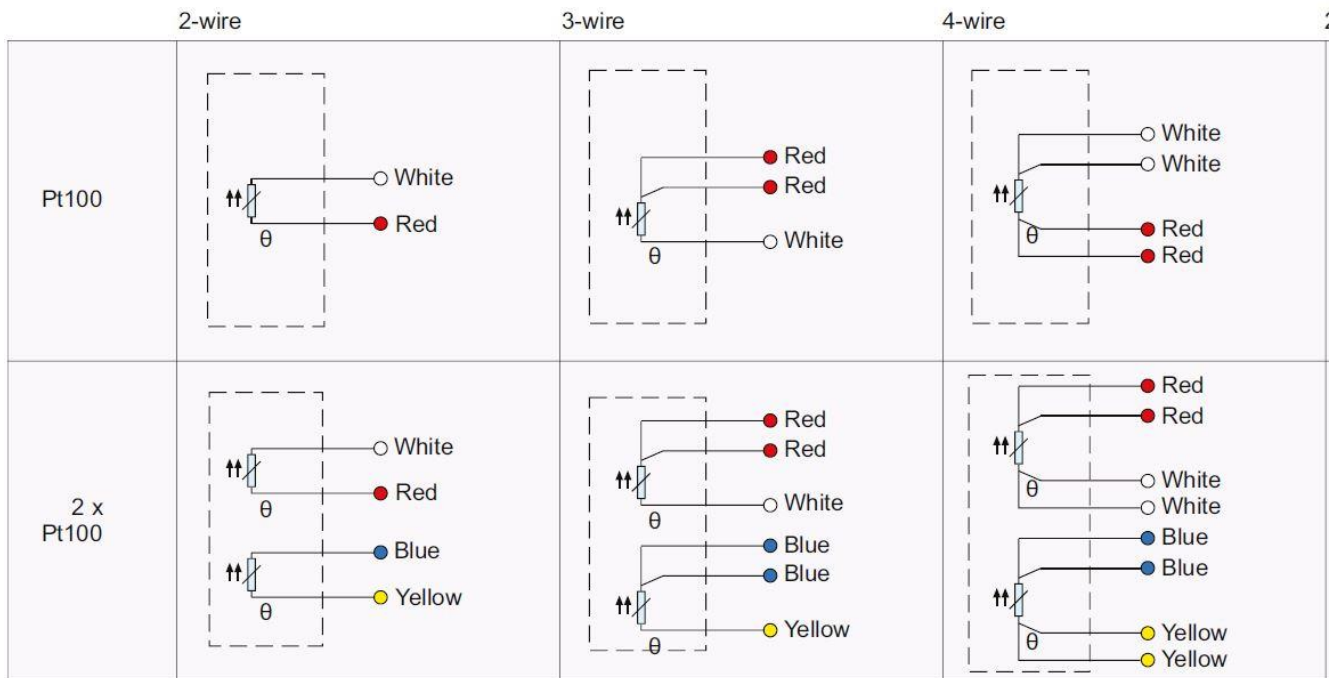

Other connections on request.

Pt100; measuring current

The highest allowed measuring current for Pt100 measuring resistors depends on resistor type and brand.

Normally the recommended maximum values are:

- Pt100 1 mA
- Pt500 0,5 mA
- Pt1000 0,3 mA.

Do not use higher measuring current. It will lead to false measurement values and might even destroy the resistor.

Above listed values are normal measuring current values. For Ex i certified sensor types, type designation -EXI-, higher values (worst case) are used for the self-heating calculation for safety reasons. For further details and calculation examples, please see ANNEX A.

TC; connection wiring

Image below: These are the connection colors of TC types J, K and N.

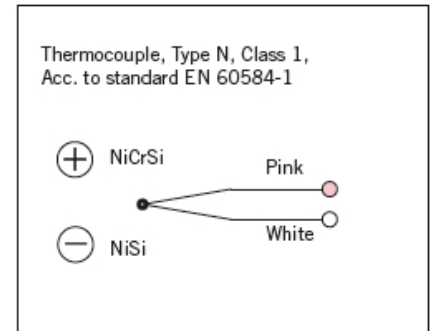
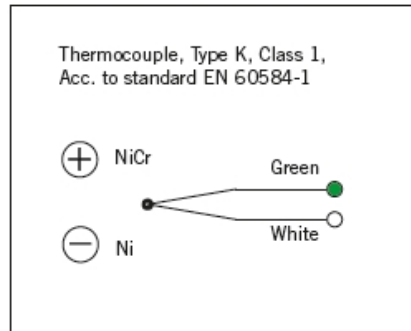
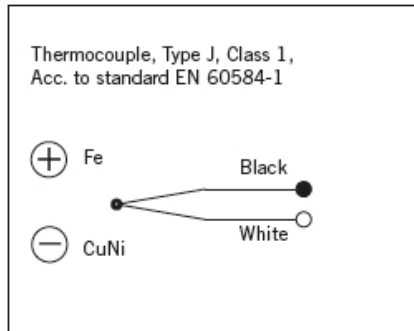

Other types on request.

TC; non-grounded or grounded types

Normally the thermocouple sensors are non-grounded, which means the protective tube / MI cable sheath is not connected to the thermo material hot junction, where two materials are welded together.

In special applications also grounded types are used.

NOTE! Non-grounded and grounded sensors cannot be connected to same circuits, make sure you are using the right type.

NOTE! Grounded TCs are not allowed for Ex i certified sensor types.

Image below: Non-grounded and grounded structures in comparison.

Non-grounded TC

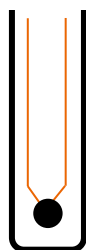





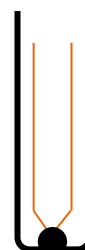











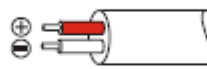

Thermo material hot junction and protective tube / MI cable sheath are galvanically isolated from each other.

Grounded TC



Thermo material hot junction has galvanic connection with protective tube / MI cable sheath.

TC; thermocouple cable standards (color table)

New standards:	IEC 60584-3	DIN EN 60584	ISA MC 96.1
Thermo Type	IEC 584	DIN 43714	ANSI MC 96.1
NiCr-Ni / K KCA: Fe-CuNi	 + green/ - white Jacket: green	 + red/ - green Jacket: green	 + yellow/ - red Jacket: yellow
Fe-CuNi / L		 + red/ - blue Jacket: blue	
Fe-CuNi / J	 + black/ - white Jacket: black		 + white/ - red Jacket: black
Pt10Rh-Pt / S SCA: E-Cu/A-Cu	 + orange/ - white Jacket: orange	 + red/ - white Jacket: white	 + black/ - red Jacket: green
Pt13Rh-Pt / R RCA: E-Cu/A-Cu	 + orange/ - white Jacket: orange	 + red/ - white Jacket: white	 + black/ - red Jacket: green
Pt30Rh-Pt6Rh / B BC: S-Cu/E-Cu	 + grey/ - white Jacket: grey		 + grey/ - red Jacket: grey
NiCrosil-Nisil / N NC: Cu-CuNi	 + pink/ - white Jacket: pink		
Cu-CuNi / U		 + red/ - brown Jacket: brown	
Cu-CuNi / T	 + brown/ - white Jacket: brown		
NiCr-CuNi / E	 + purple/ - white Jacket: purple	 + red/ - purple Jacket: purple	 + purple/ - red Jacket: purple

Type label of standard versions

Each sensor has a type label attached to it. It is a moisture and wear proof industrial grade sticker, with black text on white label. This label has printed information as presented below.

Image below: Example of a standard sensor type label.

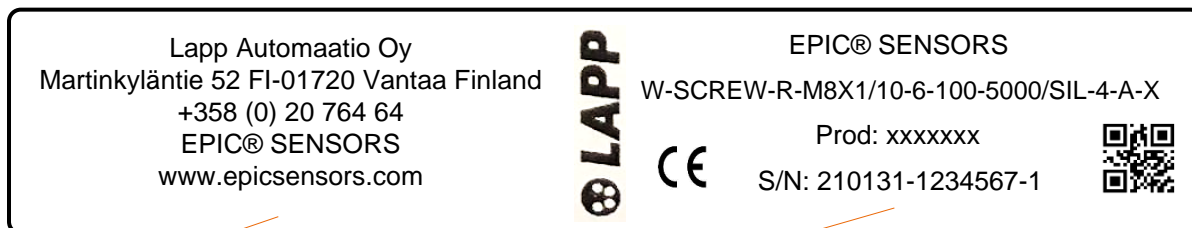

Manufacturer contact information.
For some sensor types, this part
may also be printed on a separate
label for practical reasons.

Trade name
Type code
Product number
Serial number with production date
CE-mark (RoHS) | Serial number
as QR code

Serial number information

Serial number S/N is always printed on type label in the following form: yymmdd-xxxxxxx-x:

- yymmdd production date, e.g. "210131" = 31.1.2021
- -xxxxxxx production order, e.g. "1234567"
- -x sequential ID number within this production order, e.g. "1"

Ex i data (only for types with Ex i approval)

This sensor type is available also with ATEX and IECEx Ex i approvals. Assembly consists of a temperature sensor for screw installation, with cable for connection (sensor type designation -EXI-). All relevant Ex data is given below.

Ex i – Special Conditions for Use

There are special specifications and conditions for use defined in certificates. These include e.g. Ex data, allowed ambient temperatures, and self-heating calculation with examples. These are presented in **Annex A: Specification and special conditions for use - Ex i approved EPIC®SENSORS temperature sensors.**

Ex i certificates and Ex markings

Certificate - Number	Issued by	Applicable area	Marking
ATEX – EESF 21 ATEX 043X	Eurofins Electric & Electronics Finland Oy, Finland, Notified Body Nr 0537	Europe	Ex II 1G Ex ia IIC T6...T3 Ga Ex II 1/2G Ex ib IIC T6...T3 Ga/Gb Ex II 1D Ex ia IIIC T135 °C Da Ex II 1/2D Ex ib IIIC T135 °C Da/Db
IECEx – IECEx EESF 21.0027X	Eurofins Electric & Electronics Finland Oy, Finland, Notified Body Nr 0537	Global	Ex ia IIC T6...T3 Ga Ex ib IIC T6...T3 Ga/Gb Ex ia IIIC T135 °C Da Ex ib IIIC T135 °C Da/Db

Note! Name change of the Notified Body Nr 0537:

- Until 31.3.2022, the name was: Eurofins Expert Services Oy
- As of 1.4.2022, the name is: Eurofins Electric & Electronics Finland Oy.

Ex i type label

For ATEX and IECEx Ex i approved versions there is more information on the label, according to applicable standards.

Image below: Example of an ATEX and IECEx Ex i approved sensor type label.

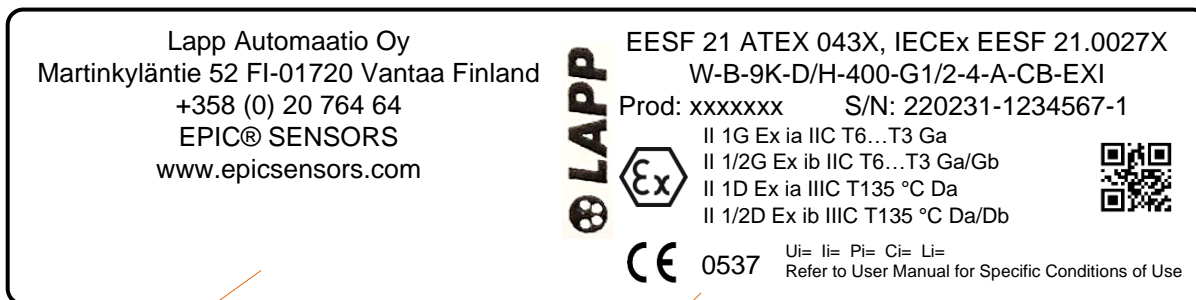

Manufacturer contact information.
For some sensor types, this may also be printed on a separate label for practical reasons.

Ex certificate number(s)
Type code
Product number Serial number with production date
Ex-mark (ATEX) Ex markings
CE-mark (ATEX and RoHS) Serial number as QR code
Notified body number
Special technical values (if needed)

EU Declaration of Conformity

The EU Declaration of Conformity, declaring products' conformance to the European Directives, is delivered with products or sent on request

Manufacturer contact information

Manufacturer HQ main office:

Lapp Automaatio Oy
Street address Martinkyläntie 52
Postal address FI-01720 Vantaa, Finland

Production site and logistics:

Lapp Automaatio Oy
Street address Varastokatu 10
Postal address FI-05800 Hyvinkää, Finland

Phone (sales) +358 20 764 6410

Email epicsensors.fi.lav@lapp.com
Https www.epicsensors.com

Document history

Version / date	Author(s)	Description
20220815	LAPP/JuPi	Material name text corrections
20220408	LAPP/JuPi	Minor text corrections
20220401	LAPP/JuPi	Original version

Although every reasonable effort is made to ensure the accuracy of the content of the operating instructions, Lapp Automaatio Oy is not responsible for the way the publications are used or for possible misinterpretations by end users. The user must ensure that she or he has the latest edition of this publication.

We reserve the right to make changes without prior notice. © Lapp Automaatio Oy

ANNEX A - Specification and special conditions for use - Ex i approved EPIC® SENSORS temperature sensors

Annex A, page 1/4

Ex data for RTD (resistance temperature sensor) and TC (Thermocouple temperature sensor)

Sensor Ex data, maximum interface values, without transmitter or / and display.

Electrical values	For Group IIC	For Group IIIC
Voltage U_i	30 V	30 V
Current I_i	100 mA	100 mA
Power P_i	750 mW	550 mW @ $T_a +100\text{ °C}$
		650 mW @ $T_a +70\text{ °C}$
		750 mW @ $T_a +40\text{ °C}$
Capacitance C_i	Negligible, *	Negligible, *
Inductance L_i	Negligible, *	Negligible, *

Table 1. Sensor Ex data.

* For sensors with long cable part, the parameters C_i and L_i must be included in the calculation.
Following values per meter can be used according to EN 60079-14:
 $C_{\text{cable}} = 200\text{ pF/m}$ and $L_{\text{cable}} = 1\text{ μH/m}$.

Allowed ambient temperatures - Ex i temperature class, without transmitter and/or display.

Marking, Gas Group IIC	Temperature class	Ambient temperature
II 1G Ex ia IIC T6 Ga II 1/2G Ex ib IIC T6-T3 Ga/Gb	T6	-40...+80 °C
II 1G Ex ia IIC T5 Ga II 1/2G Ex ib IIC T6-T3 Ga/Gb	T5	-40...+95 °C
II 1G Ex ia IIC T4-T3 Ga II 1/2G Ex ib IIC T6-T3 Ga/Gb	T4-T3	-40...+100 °C
Marking, Dust Group IIIC	Power P_i	Ambient temperature
II 1D Ex ia IIIC T135 °C Da II 1/2D Ex ib IIIC T135 °C Da/Db	750 mW	-40...+40 °C
II 1D Ex ia IIIC T135 °C Da II 1/2D Ex ib IIIC T135 °C Da/Db	650 mW	-40...+70 °C
II 1D Ex ia IIIC T135 °C Da II 1/2D Ex ib IIIC T135 °C Da/Db	550 mW	-40...+100 °C

Table 2. Ex i temperature classes and allowed ambient temperature ranges

Note!

The temperatures above are without cable glands.

The compatibility of cable glands must be according to the application specifications.

If the transmitter and/or display will be inside the transmitter housing, the specific Ex requirements of the transmitter and/or display installation must be noted.

The used materials must comply the needs of application, e.g., abrasion, and the temperatures above.

For EPL Ga Group IIC the aluminium parts in connection heads are subject to sparking by impacts or friction.

For Group IIIC the maximum input power P_i shall be observed.

When the sensors are mounted across boundary between different Zones, refer to standard IEC 60079-26 section 6, for ensuring the boundary wall between different hazardous areas.

ANNEX A - Specification and special conditions for use - Ex i approved EPIC® SENSORS temperature sensors

Annex A, page 2/4

Considering sensor self-heating

Self-heating of the sensor tip shall be considered in respect with Temperature Classification and associated ambient temperature range and manufacturer's instructions for calculating tip surface temperature according to thermal resistances stated in the instructions shall be observed.

Allowed ambient temperature range of sensor head or process connection for Groups IIC and IIIC with different temperature classes are listed in Table 2. For Group IIIC the maximum input power P_i shall be observed.

The process temperature shall not adversely affect ambient temperature range assigned for Temperature Classification.

Calculation for self-heating of the sensor at the tip of sensor or the thermowell tip

When the sensor-tip is located at environment where the temperature is within $T_6...T_3$, it is needed to consider the self-heating of the sensor. Self-heating is of particular significance when measuring low temperatures.

The self-heating at the sensor tip or thermowell tip depends on the sensor type (RTD/TC), the diameter of sensor and structure of sensor. It is also needed to consider the Ex i values for the transmitter. The table 3. shows the R_{th} values for different type of sensors structure.

Sensor type	Thermal resistance R_{th} [°C / W]					
	Resistance thermometer (RTD)			Thermocouple (TC)		
Measuring insert diameter	< 3 mm	3...<6 mm	6...8 mm	< 3 mm	3...<6 mm	6...8 mm
Without thermowell	350	250	100	100	25	10
With thermowell made from tube material (e.g. B-6k, B-9K, B-6, B-9, A-15, A-22, F-11, etc)	185	140	55	50	13	5
With thermowell – solid material (e.g. D-Dx, A-Ø-U)	65	50	20	20	5	1

Table 3. Thermal resistance based on Test report 211126

Note!

If the measuring device for RTD-measuring is using measuring current > 1 mA, the maximum surface temperature of the temperature sensor tip should be calculated and taken to account. Please see next page.

If sensor type has multiple sensing elements included, and those are used simultaneously, note that the maximum power for all sensing elements should not be more than the allowed total power P_i . Maximum power must be limited to 750 mW. This must be guaranteed by process owner. (Not applicable for Multi-point temperature sensor types T-MP / W-MP or T-MPT / W-MPT with segregated Exi circuits).

ANNEX A - Specification and special conditions for use - Ex i approved EPIC® SENSORS temperature sensors

Annex A, page 3/4

Calculation for maximum temperature:

The self-heating of the sensor tip can be calculated from formula:

$$T_{max} = P_o \times R_{th} + MT$$

- (T_{max}) = Maximum temperature = surface temperature at the sensor tip
- (P_o) = Maximum feeding power for the sensor (see the transmitter certificate)
- (R_{th}) = Thermal resistance (K/W, Table 3.)
- (MT) = Medium temperature.

Calculate the maximum possible temperature at the tip of sensor:

Example 1 - Calculation for RTD-sensor tip with thermowell

Sensor used at Zone 0

RTD sensor type: W-M-9K . . . (RTD-sensor with head-mounted transmitter).

Sensor with thermowell, diameter of Ø 9 mm.

Medium temperature (MT) is 120 °C

Measuring is made with PR electronics head mounted transmitter 5437D and isolated barrier PR 9106 B.

Maximum temperature (T_{max}) can be calculated by adding the temperature of the medium that you are measuring and the self-heating. The self-heating of the sensor tip can be calculated from the Maximum power (P_o) which is feeding the sensor and R_{th}-value of used sensor type. (See the Table 3.)

Supplied power by PR 5437 D is (P_o) = 23,3 mW (from the transmitter Ex-certificate)

Temperature class T4 (135 °C) must not be exceeded.

Thermal resistance (R_{th}) for the sensor is = 55 K/W (from Table 3).

Self-heating is $0.0233 \text{ W} \times 55 \text{ K/W} = 1,28 \text{ K}$

Maximum temperature (T_{max}) is MT + self-heating: 120 °C + 1,28 °C = 121,28 °C

The result in this example shows that, the self-heating at the sensor tip is negligible.

The safety margin for (T₆ to T₃) is 5 °C and that must be subtracted from 135 °C; means that up to 130 °C would be acceptable. In this example the temperature of class T4 is not exceeded.

Example 2 - Calculation for RTD-sensor tip without the thermowell.

Sensor used at Zone 1

RTD sensor type: W-M-6/303 . . . (RTD-sensor with cable, without head-mounted transmitter)

Sensor without thermowell, diameter of Ø 6 mm.

Medium temperature (MT) is 40 °C

Measuring is made with rail-mounted PR electronics PR 9113D isolated transmitter/barrier.

Maximum temperature (T_{max}) can be calculated by adding the temperature of the medium that you are measuring and the self-heating. The self-heating of the sensor tip can be calculated from the Maximum power (P_o) which is feeding the sensor and R_{th}-value of used sensor type. (See the Table 3.)

Supplied power by PR 9113D is (P_o) = 40,0 mW (from the transmitter Ex-certificate)

Temperature class T3 (200 °C) must not be exceeded.

Thermal resistance (R_{th}) for the sensor is = 100 K/W (from Table 3).

Self-heating is $0.040 \text{ W} \times 100 \text{ K/W} = 4,00 \text{ K}$

Maximum temperature (T_{max}) is MT + self-heating: 40 °C + 4,00 °C = 44,00 °C

The result in this example shows that, the self-heating at the sensor tip is negligible.

The safety margin for (T₆ to T₃) is 5 °C and that must be subtracted from 200 °C; means that up to 195 °C would be acceptable. In this example the temperature of class T3 is not exceeded.

ANNEX A - Specification and special conditions for use
- Ex i approved EPIC® SENSORS temperature sensors

Annex A, page 4/4

Additional information for Group II devices: (acc. to EN IEC 60079-0: 2019 section: 5.3.2.2 and 26.5.1)

Temperature class for T3 = 200 °C

Temperature class for T4 = 135 °C

Safety margin for T3 to T6 = 5 K

Safety margin for T1 to T2 = 10 K.

Note!

This ANNEX is an instructional document on specifications.

For original regulatory data on specific conditions for use, always refer to ATEX and IECEx certificates:

EESF 21 ATEX 043X
IECEx EESF 21.0027X